

KATALOG

KLIZNE STAKLENE PREGRADE AB100



EURO-ROAL

DOBOJ JUG | CAZIN | HADŽIĆI | ZAGREB | PODGORICA

www.euroroal.com

-KLIZNE STAKLENE PREGRADE AB100

- Moguća ugradnja stakla debljine 8mm;
- Štok sa 3 i 5 kliznih staza;
- Jednostavna ugradnja;
- Ekonomičan;
- Maksimalna visina stakla 2,5 metra, dok je maksimalna širina krila 1 metar;
- Štok je moguće ugraditi sa pragom, ali i bez praga.

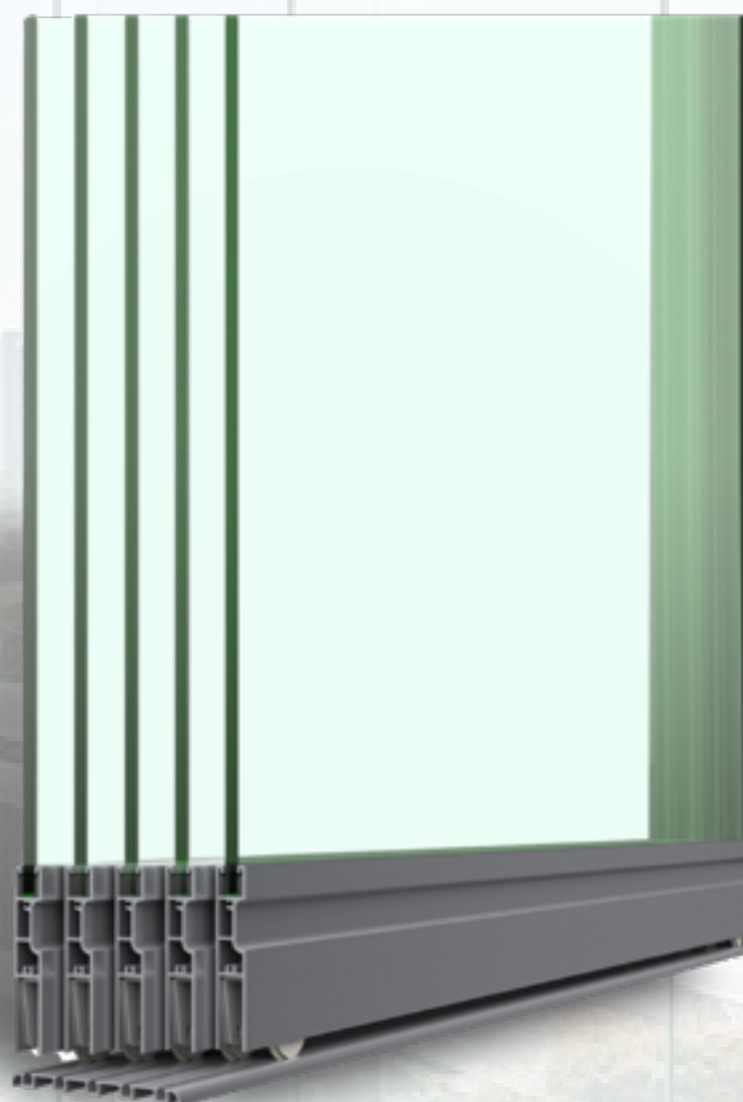

Šifra artikla	Naziv artikla	Cijena/KOM	
33600 (SS-AC-08A)	AB 100 DONJI POKLOPAC KRILA A		
Napomena: +PDV			

Šifra artikla	Naziv artikla	Cijena/KOM	
33601 (SS-AC-08B)	AB 100 DONJI POKLOPAC KRILA B		
Napomena: +PDV			

Šifra artikla	Naziv artikla	Cijena/KOM	
33602 (SCALA1124)	AB 100 SPOJNICA STOKA 1124		
Napomena: +PDV			

Šifra artikla	Naziv artikla	Cijena/KOM	
33603 (M019)	AB 100 M019 SPOJNICA		
Napomena: +PDV			

Šifra artikla	Naziv artikla	Cijena/KOM	
33604 (SS-AC-03)	AB 100 GORNJI TOCKICI		
Napomena: +PDV			









Šifra artikla	Naziv artikla	Cijena/KOM	
33605 (SS-AC-02B)	AB 100 DONJI TOCKICI		
Napomena: +PDV			

Šifra artikla	Naziv artikla	Cijena/KOM	
33606 (SS-AC-06)	AB 100 BRAVA Z400		
Napomena: +PDV			











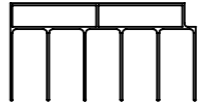

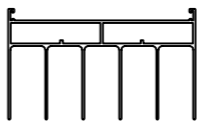

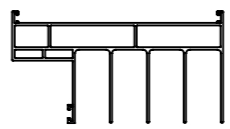
Šifra artikla	Naziv artikla	Cijena/KOM	
33607 (SS-AC-10)	AB 100 RUCKA		
Napomena: +PDV			

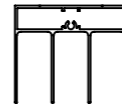
Šifra artikla	Naziv artikla	Cijena/KOM	
33608 (SS-AC-11)	AB 100 SIGURNOSNA BRAVA IZNUTRA		
Napomena: +PDV			

-KLIZNE STAKLENE PREGRADE AB100

Šifra artikla	Naziv artikla	Cijena/KOM	
33609 (SS-AC-12)	AB 100 CETRALNI POKLOPAC BRAVE		
Napomena: +PDV			
33610 (ASI-PB-219)	AB 100 UGAO 219		
Napomena: +PDV			
33611 (AB100-301)	AB 100 STOK VODILICA ZA 3 KRILA S1		
Napomena: +PDV			
33612 (AB100-302)	AB 100 DONJA VODILICA ZA 3 KRILA S1		
Napomena: +PDV			
33613 (AB100-3460)	AB 100 KRILO 8mm S1		
Napomena: +PDV			
33615 (AB100-3464)	AB 100 VERT.PROFIL ZA KRILO S1		
Napomena: +PDV			
33614 (AB100-3463)	AB 100 GORNJI PROFIL ZA KRILO S1		
Napomena: +PDV			
33616 (Z400-01)	AB 100 STOK VODILICA ZA 5 KRILA S1		
Napomena: +PDV			
33617 (Z400-02)	AB 100 DONJA VODILICA ZA 5 KRILA S1		
Napomena: +PDV			

PROFILI

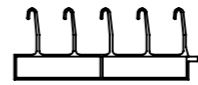
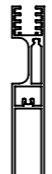
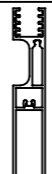
Šifra artikla	Naziv artikla	Cijena/KOM	
AB100-3457	ÜST -YAN KASA PROFİLİ TOP-VERTICAL FRAME PROFILE	AĞIRLIK / Weight 1,535 kg/mt	
AB100-3464	ÜST KANAT PROFİLİ 8mm CAM İÇİN TOP SASH PROFILE	AĞIRLIK / Weight 0,153 kg/mt	
Z400-01	ÜST -YAN KASA PROFİLİ TOP-VERTICAL FRAME PROFILE	AĞIRLIK / Weight 1,779 kg/mt	
AB100-3463	YAN KANAT PROFİLİ 8mm CAM İÇİN VERTICAL SASH PROFILE	AĞIRLIK / Weight 0,141 kg/mt	
Z400-03	CAM KAPI KASA PROFİLİ GLASS DOOR FRAME PROFILE	AĞIRLIK / Weight 1,962 kg/mt	
Z400-41	KANAT BİTİŞ PROFİLİ 8mm CAM İÇİN VERTICAL SASH PROFILE	AĞIRLIK / Weight 0,161 kg/mt	
AB100-301	ÜST -YAN KASA PROFİLİ TOP-VERTICAL FRAME PROFILE	AĞIRLIK / Weight 1,087 kg/mt	
AB100-3465	YAN KANAT PROFİLİ 10mm CAM İÇİN VERTICAL SASH PROFILE	AĞIRLIK / Weight 0,133 kg/mt	
Z400-04	CAM KAPI ALT KASA PROFİLİ BOTTOM FRAME PROFILE	AĞIRLIK / Weight 0,878 kg/mt	
Z400-43	KANAT BİTİŞ PROFİLİ 10mm CAM İÇİN VERTICAL SASH PROFILE	AĞIRLIK / Weight 0,155 kg/mt	
Z400-02	EŞİKSİZ KASA PROFİLİ BOTTOM FRAME PROFILE	AĞIRLIK / Weight 0,588 kg/mt	
Z400-44	ÜST KANAT PROFİLİ 10mm CAM İÇİN TOP SASH PROFILE	AĞIRLIK / Weight 0,177 kg/mt	
AB100-302	EŞİKSİZ KASA PROFİLİ BOTTOM FRAME PROFILE	AĞIRLIK / Weight 0,365 kg/mt	
Z400-44-N	ÜST KANAT PROFİLİ 10mm CAM İÇİN TOP SASH PROFILE	AĞIRLIK / Weight 0,180 kg/mt	
AB100-3458	EŞİKLİ KASA PROFİLİ BOTTOM FRAME PROFILE	AĞIRLIK / Weight 1,309 kg/mt	
AB100-3460	ALT KANAT PROFİLİ 8mm CAM İÇİN BOTTOM SASH PROFILE	AĞIRLIK / Weight 1,088 kg/mt	
AB100-3459	ALT KANAT PROFİLİ 10mm CAM İÇİN BOTTOM SASH PROFILE	AĞIRLIK / Weight 1,114 kg/mt	

PRIBOR

SS AC-08A			SS AC-02B		
EŞİKSİZ KASA ALT KANAT KAPAK - A SAĞA SÜRÜLÜR KANAT BOTTOM SASH COVER-RIGHT	KOLİ MIKTARI/Package Takım / Set		EŞİKSİZ KASA ALT RULMAN - 2 Lİ BOTTOM ROLLER	KOLİ MIKTARI/Package Adet / Piece	
SS AC-08B			SS AC-03		
EŞİKSİZ KASA ALT KANAT KAPAK - B SOLA SÜRÜLÜR KANAT BOTTOM SASH COVER-LEFT	KOLİ MIKTARI/Package Takım / Set		ÜST RULMAN TOP ROLLER	KOLİ MIKTARI/Package Adet / Piece	
SS AC-08C			SS AC-06		
EŞİKLİ KASA ALT KANAT KAPAK - C SAĞA SÜRÜLÜR KANAT BOTTOM SASH COVER-RIGHT	KOLİ MIKTARI/Package Takım / Set		GÜVENLİK KİLİTLEME SECURITY LOCK	KOLİ MIKTARI/Package Adet / Piece	
SS AC-08D			SS AC-07		
EŞİKLİ KASA ALT KANAT KAPAK - D SOLA SÜRÜLÜR KANAT BOTTOM SASH COVER-LEFT	KOLİ MIKTARI/Package Takım / Set		EŞİKLİ KASA ALT RULMAN BOTTOM ROLLER	KOLİ MIKTARI/Package Adet / Piece	
ASI-PB 1124			KF 67-400		
PİMLİ KÖŞE BAĞLANTI CORNER JOINT	KOLİ MIKTARI/Package 200 Adet / Piece		FİRÇA FİTİL - 4 mm BRUSH GASKET	KOLİ MIKTARI/Package 1400 mt	
SS AC-09			KF 67-550		
KASA KÖŞE TAKOZU FRAME CORNER JOINT	KOLİ MIKTARI/Package Takım / Set		FİRÇA FİTİL - 5,5 mm BRUSH GASKET	KOLİ MIKTARI/Package 1400 mt	
ASI-KT 1126			SS AC-10		
KÖŞE TAKOZU PRES CORNER JOINT	KOLİ MIKTARI/Package Adet / Piece		ÇEKME KOL PULL HANDLE	KOLİ MIKTARI/Package Adet / Piece	
ASI-AT 219			SS AC-11		
KÖŞE BAĞLANTI CORNER JOINT	KOLİ MIKTARI/Package Adet / Piece		SÜRME CAM İÇ KİLİT-PVC SECURITY LOCK FOR INSIDE	KOLİ MIKTARI/Package Adet / Piece	
ASI-SB 19			SS AC-12		
KÖŞE GÖNYESİ CORNER ALIGNMENT	KOLİ MIKTARI/Package Adet / Piece		ORTA KANAT BİRLEŞİM KAPAKLARI CENTRAL LOCKING COVER	KOLİ MIKTARI/Package Takım / Set	
SS AC-02			SS AC-13		
EŞİKSİZ KASA ALT RULMAN - TEKLİ BOTTOM ROLLER	KOLİ MIKTARI/Package Adet / Piece		METAL SÜRME CAM İÇ KİLİT SECURITY LOCK FOR INSIDE	KOLİ MIKTARI/Package Adet / Piece	

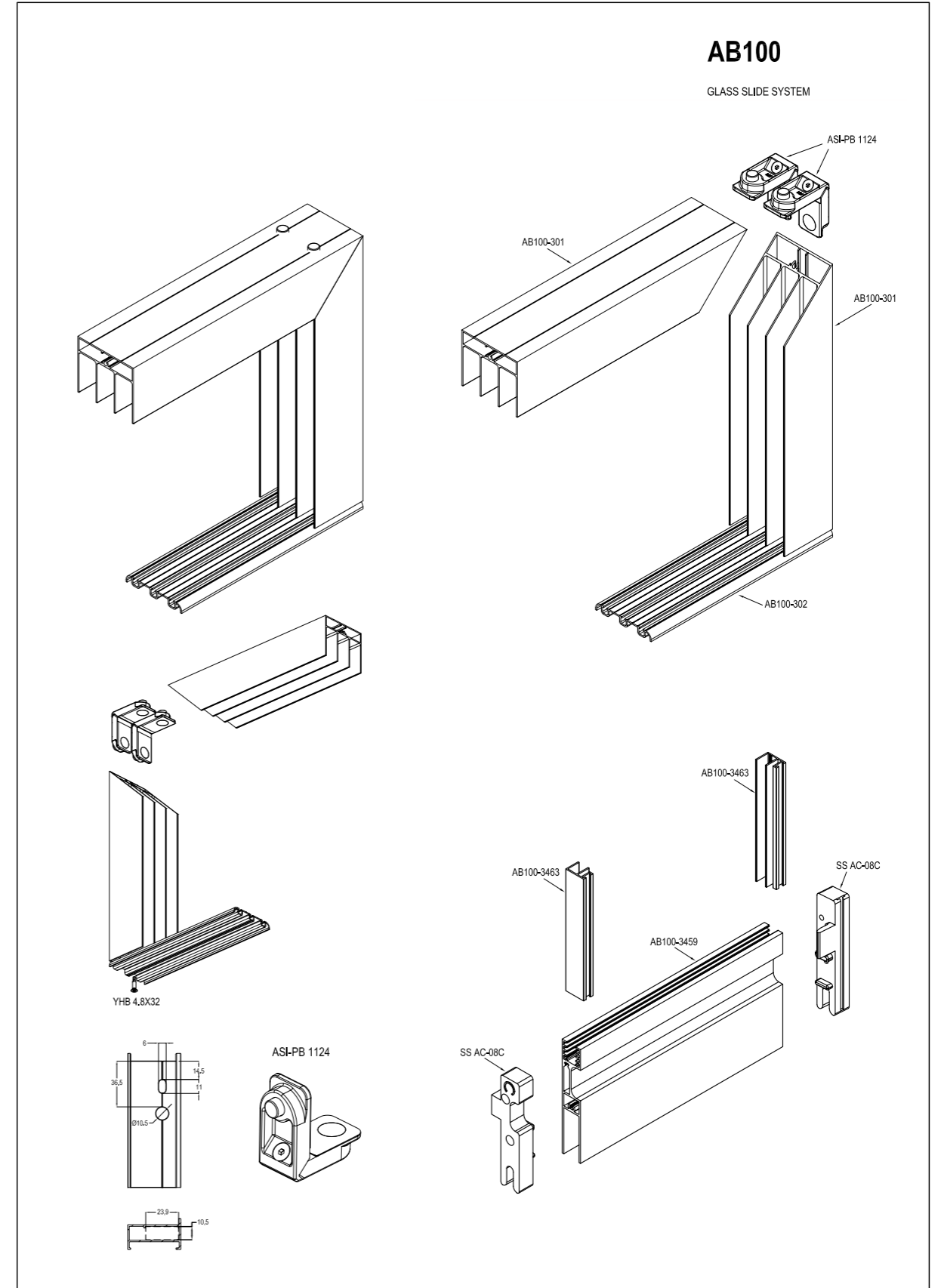

AB100

GLASS SLIDE SYSTEM

ASSEMBLY FOR THRESHOLD FRAME

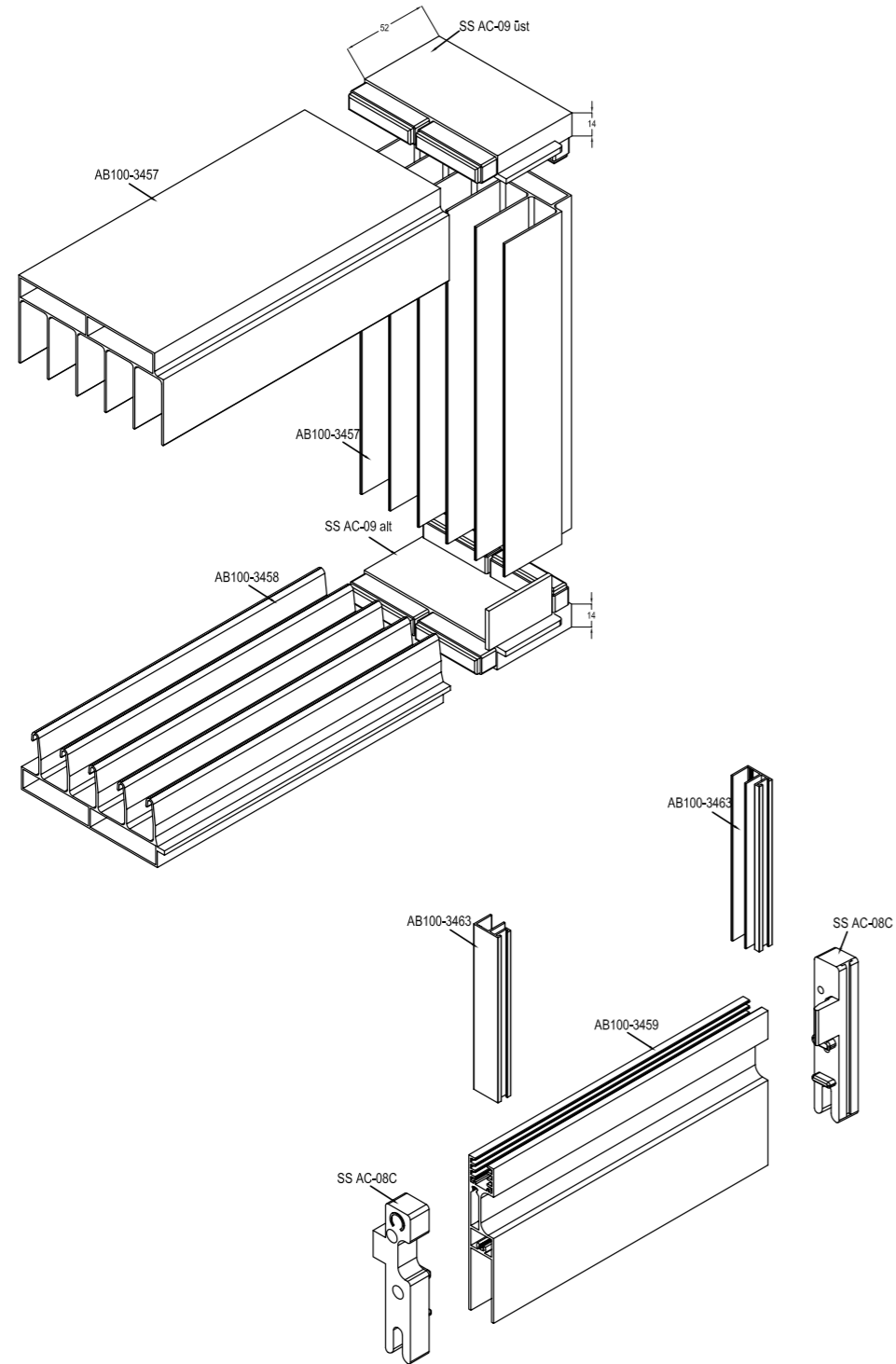

AB100

GLASS SLIDE SYSTEM

ASSEMBLY FOR NO THRESHOLD FRAME

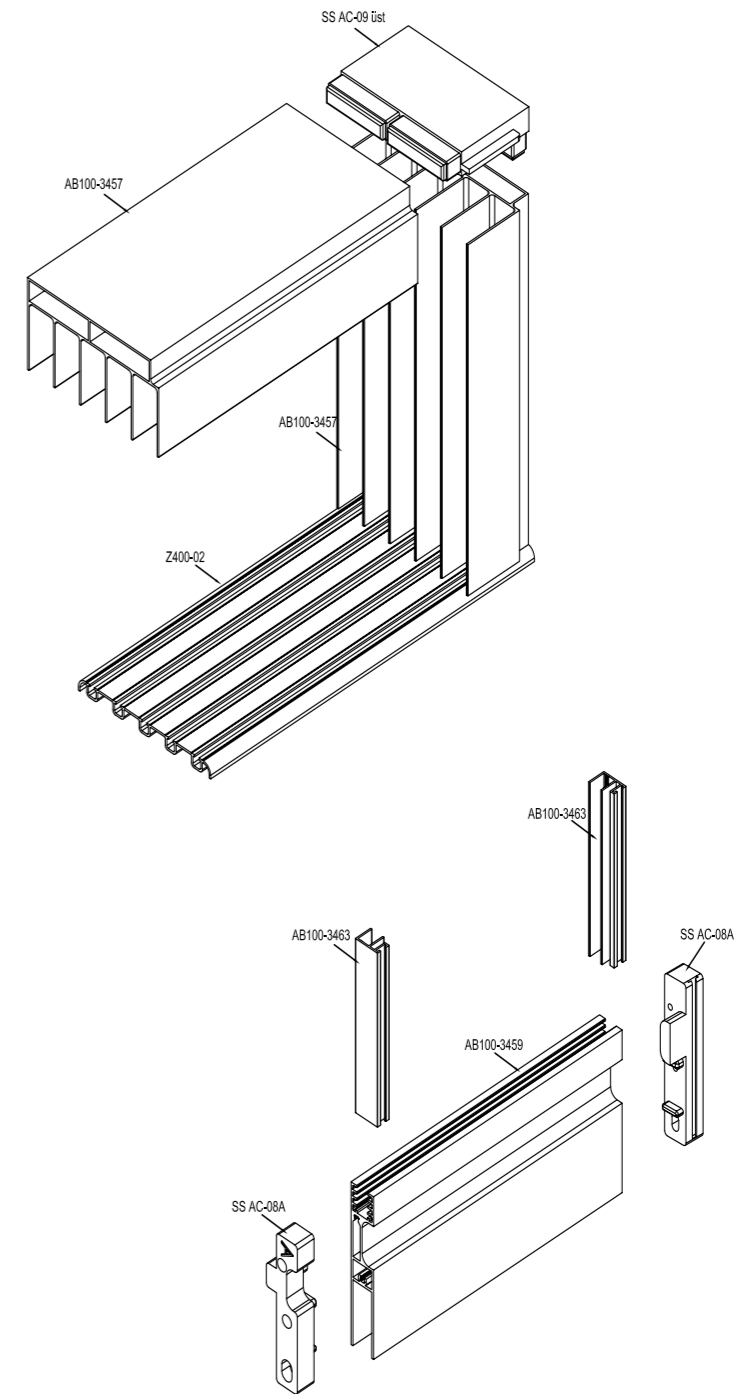

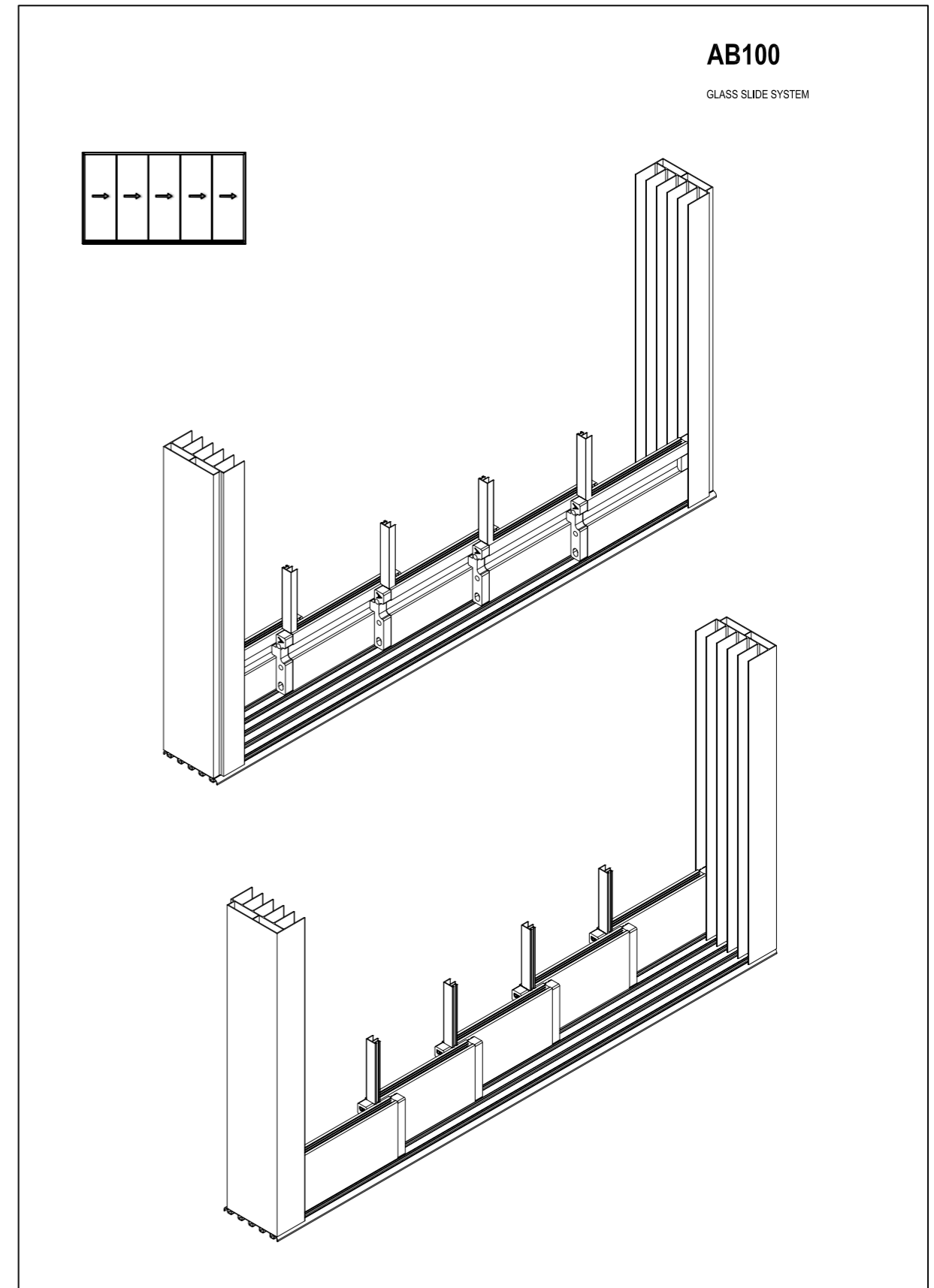
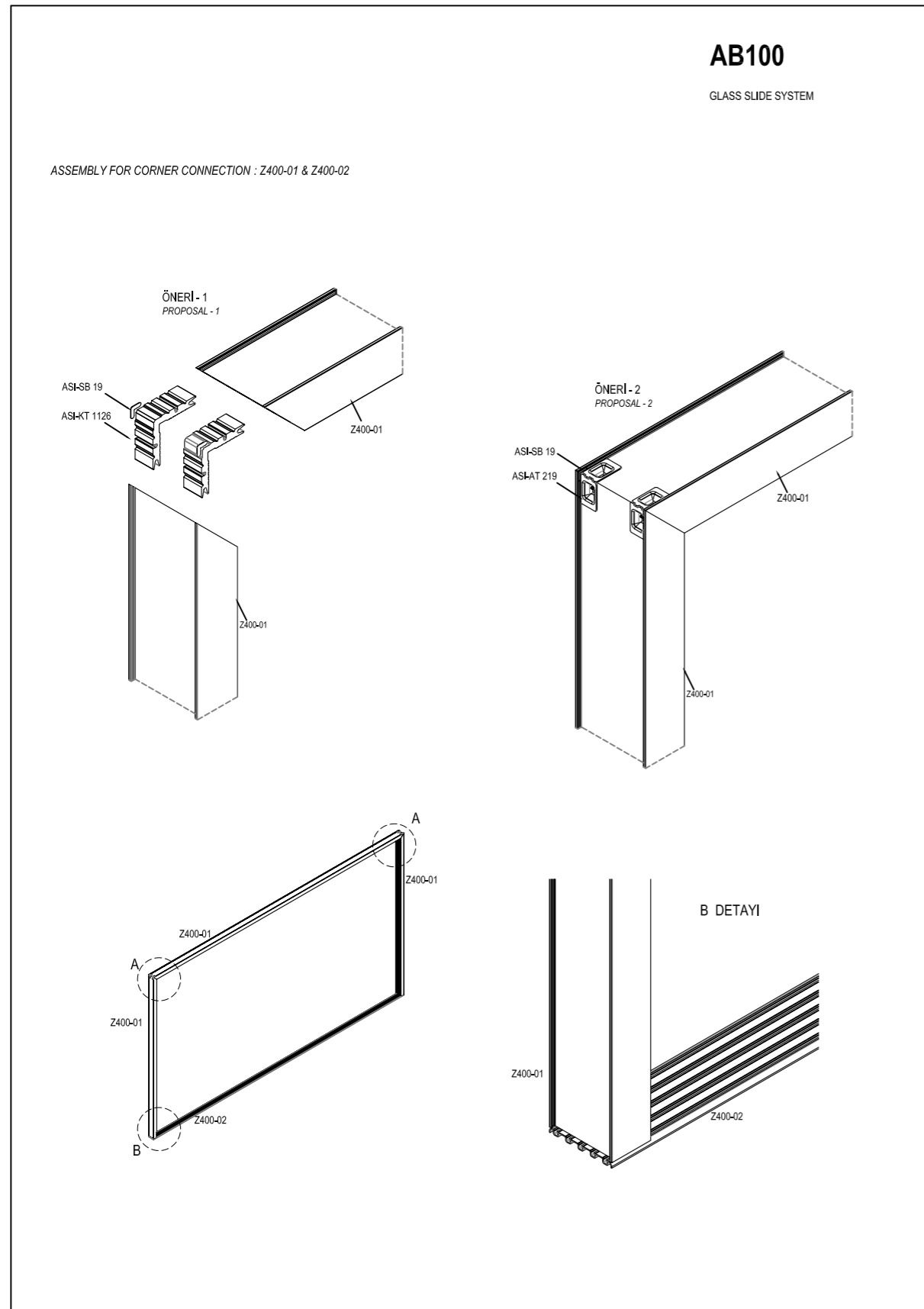

ESKİSZ KASA MONTAJI - 8mm CAM İÇİN
SOLA SÜRÜLÜR KANAT
ASSEMBLY FOR NO THRESHOLD FRAME - FOR 8mm GLASS
SLIDING TO THE LEFT WAY

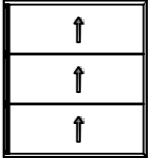

•MAX KANAT YÜKSEKLİĞİ (ÇERÇİVE İÇİN) 2000mm
•MAX KANAT ENİ 1800mm (TOPLAM KANAT ALANI 4m² GEÇEMEKLİ RULMAN TAŞIMAK KAPASİTESİ OLMAYAN SİSTEMLER İÇİN)
•MAX SİLİNDİR ÇAP 30mm (TOPLAM SİLİNDİR KESİMLERİNİN ENİ RULMAN TAŞIMAK KAPASİTESİ İÇİN)

CAM KESİM ÖLÇÜLERİ / GLASS CUTTING SIZES		KESİM ÖLÇÜSÜ / Cutting Dimensions	
KOD / Code	TANIMI / Description	FW - 60mm / 3" + 20mm	FH - 135mm
GW	KANAT CAM GENİŞLİĞİ / Sash Glass Width		
GH	KANAT CAM YÜKSEKLİĞİ / Sash Glass Height		

LEFT SLIDING
SOLA SÜRÜLÜR KANATLAR

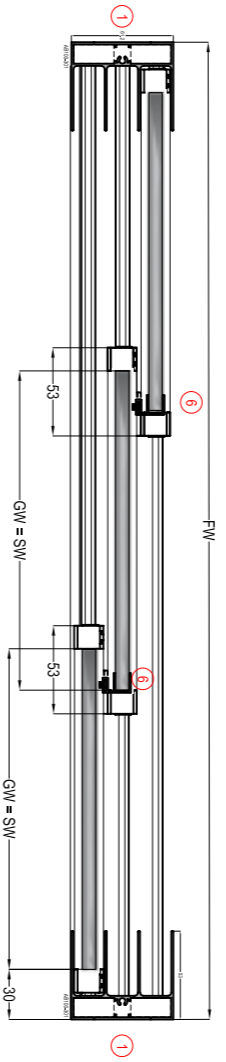

PROFİLLER / PROFILES		KESİM ÖLÇÜSÜ / Cutting Dimensions			
NO / Number	ADET / Unit	KOD / Code	PROFİL ÇİZİMİ / Drawing	PROFİL TANIMI / Description	KESİM ÖLÇÜSÜ / Cutting Dimensions
1	2	AB100-201		YAN KASA PROFİLİ / Vertical Frame Profile	FH - 75mm
2	1	AB100-201		ÜST KASA PROFİLİ / Top Frame Profile	FW
3	1	AB100-202		ESKİSZ ALT KASA PROFİLİ / Bottom Profile with no Threshold	FW
4	3	AB100-240		ALT KANAT PROFİLİ / Bottom Sash Profile	(FW - 60mm) / 3" + 20mm
5	3	AB100-244		ÜST KANAT PROFİLİ / Top Sash Profile	(FW - 60mm) / 3" + 20mm
6	2	AB100-243		KANAT YANI PROFİLİ / Sash Side Profile	FH - 135mm

AKSESUARLAR / ACCESSORIES			
MİKTAR / Unit	KOD / Code	PROFİL ÇİZİMİ / Drawing	PROFİL TANIMI / Description
6 Adet / Pcs	SS AC-3		ÜST RULMAN / Top Roller
6 Adet / Pcs	SS AC-2B		ESKİSZ KASA RULMANI / Bottom Roller
1 TAKIM / Set	SS AC-2BA		KANAT ALT KÖŞKÜ / Bottom Sash Cover
3 TAKIM / Set	SS AC-2BB		KANAT ALT KÖŞKÜ / Bottom Sash Cover
4 Adet / Pcs	AS-191124		KASA KÖŞE TAKIMI / Frame Corner Joint
1 Adet / Pcs	SS AC-10		ÇEKME KOL / Pull Handle
2 Adet / Pcs	SS AC-6		GÜVENLİK KİLİTLİME / Security Locking
2 Adet / Pcs	SS AC-11		SİLİNDİR CAM KİLİTLİME / Locking For Hide
(2SS1 + 3SS1) mt	KF 61-550		FIRÇA FİTLİ / Brush Gasket

•SEÇENEK OLARAK EKTRM KULLANILABİLİR - ADDITIONAL AVAILABLE AS OPTION

AB100
GLASS SLIDE SYSTEM

ESKİSZ KASA MONTAJI - 8mm CAM İÇİN
SAĞA SÜRÜLÜR KANAT
ASSEMBLY FOR NO THRESHOLD FRAME - FOR 8mm GLASS
SLIDING TO THE RIGHT WAY

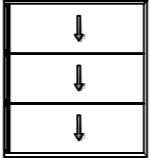

•MAX KANAT YÜKSEKLİĞİ (ÇERÇİVE İÇİN) 2000mm
•MAX KANAT ENİ 1800mm (TOPLAM KANAT ALANI 4m² GEÇEMEKLİ RULMAN TAŞIMAK KAPASİTESİ OLMAYAN SİSTEMLER İÇİN)
•MAX SİLİNDİR ÇAP 30mm (TOPLAM SİLİNDİR KESİMLERİNİN ENİ RULMAN TAŞIMAK KAPASİTESİ İÇİN)

CAM KESİM ÖLÇÜLERİ / GLASS CUTTING SIZES		KESİM ÖLÇÜSÜ / Cutting Dimensions	
KOD / Code	TANIMI / Description	FW - 60mm / 3" + 20mm	FH - 135mm
GW	KANAT CAM GENİŞLİĞİ / Sash Glass Width		
GH	KANAT CAM YÜKSEKLİĞİ / Sash Glass Height		

RIGHT SLIDING
SAĞA SÜRÜLÜR KANATLAR

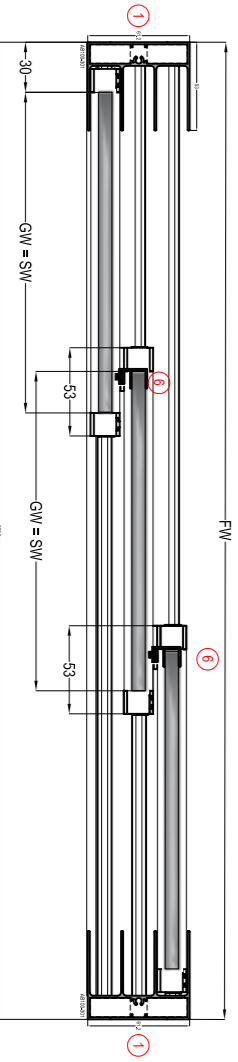

PROFİLLER / PROFILES		KESİM ÖLÇÜSÜ / Cutting Dimensions			
NO / Number	ADET / Unit	KOD / Code	PROFİL ÇİZİMİ / Drawing	PROFİL TANIMI / Description	KESİM ÖLÇÜSÜ / Cutting Dimensions
1	2	AB100-201		YAN KASA PROFİLİ / Vertical Frame Profile	FH - 75mm
2	1	AB100-201		ÜST KASA PROFİLİ / Top Frame Profile	FW
3	1	AB100-202		ESKİSZ ALT KASA PROFİLİ / Bottom Profile with no Threshold	FW
4	3	AB100-240		ALT KANAT PROFİLİ / Bottom Sash Profile	(FW - 60mm) / 3" + 20mm
5	3	AB100-244		ÜST KANAT PROFİLİ / Top Sash Profile	(FW - 60mm) / 3" + 20mm
6	2	AB100-243		KANAT YANI PROFİLİ / Sash Side Profile	FH - 135mm

AKSESUARLAR / ACCESSORIES			
MİKTAR / Unit	KOD / Code	PROFİL ÇİZİMİ / Drawing	PROFİL TANIMI / Description
6 Adet / Pcs	SS AC-3		ÜST RULMAN / Top Roller
6 Adet / Pcs	SS AC-2B		ESKİSZ KASA RULMANI / Bottom Roller
3 TAKIM / Set	SS AC-2BA		KANAT ALT KÖŞKÜ / Bottom Sash Cover
1 TAKIM / Set	SS AC-2BB		KANAT ALT KÖŞKÜ / Bottom Sash Cover
3 Adet / Pcs	AS-191124		KASA KÖŞE TAKIMI / Frame Corner Joint
1 Adet / Pcs	SS AC-10		ÇEKME KOL / Pull Handle
2 Adet / Pcs	SS AC-6		GÜVENLİK KİLİTLİME / Security Locking
2 Adet / Pcs	SS AC-11		SİLİNDİR CAM KİLİTLİME / Locking For Hide
(2SS1 + 3SS1) mt	KF 61-550		FIRÇA FİTLİ / Brush Gasket

•SEÇENEK OLARAK EKTRM KULLANILABİLİR - ADDITIONAL AVAILABLE AS OPTION

AB100
GLASS SLIDE SYSTEM

ESKİSİZ KASA MONTAJI - 8mm CAM İÇİN
SAĞA SÜRÜLÜR KANAT
ASSEMBLY FOR NO THRESHOLD FRAME - FOR 8mm GLASS
SLIDING TO THE RIGHT WAY

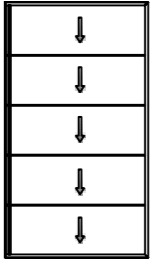

•MAX KANAT YÜKSEKLİĞİ İÇ MEKAN 3000mm, DİŞ MEKAN 2500mm
•MAX KANAT YERİHTİSİ 3000mm İNDECE 2500mm ÖLÇÜDE
•MAX KANAT ENİ 1800mm (TÜPÇAM KANAT ALANI 4m2 Yİ GEÇEMEBİLİR RULMANI TAŞIMA KAPASİTESİ ORTALAMA 8kg)
•MAX SÜRÜLME YERİ 1800mm (TÜPÇAM KANAT ALANI 4m2 Yİ GEÇEMEBİLİR RULMANI TAŞIMA KAPASİTESİ ORTALAMA 8kg)

CAM KESİM ÖLÇÜLERİ / GLASS CUTTING SIZES		
KODU / Code	TANIMI / Description	KESİM ÖLÇÜSÜ / Cutting Dimensions
GW	KANAT CAM GENİŞLİĞİ / Sash Glass Width	(FW - 60mm) G1 + 20mm
GH	KANAT CAM YÜKSEKLİĞİ / Sash Glass Height	FH + 15mm

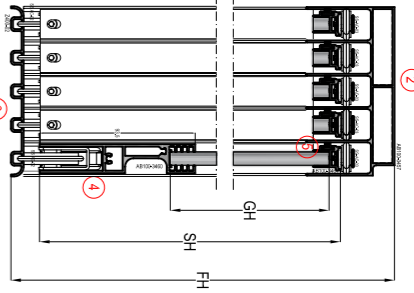

RIGHT SLIDING
SAĞA SÜRÜLÜR KANATLAR

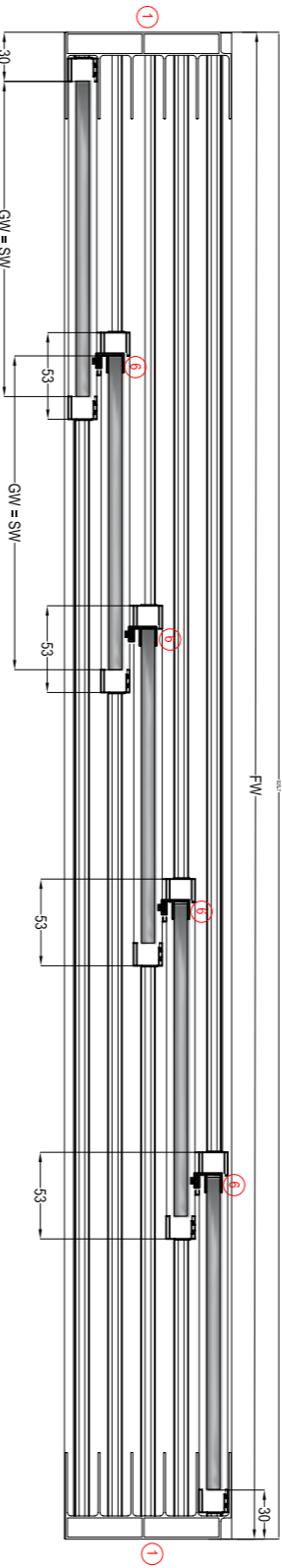

AB100
SÜRME CAM BALKON SİSTEMİ
GLASS SLIDE SYSTEM

PROFİLLER / PROFILES

KOD / ADET / Ünit / Code	PROFİL ÇİZİMİ / Drawing	PROFİL TANIMI / Description	KESİM ÖLÇÜSÜ / Cutting Dimensions
1	AB100-347	YAN KASA PROFİLİ / Vertical Finap Profile	FH - 22mm
2	AB100-347	ÜST KASA PROFİLİ / Top Frame Profile	FW + 10mm
3	Z400-02	ESKİSİZ ALT KASA PROFİLİ / Bottom Profile with No Threshold	FW
4	AB100-348	ALT KANAT PROFİLİ / Bottom Sash Profile	(FW - 60mm) G1 + 20mm
5	AB100-344	ÜST KANAT PROFİLİ / Top Sash Profile	(FW - 60mm) G1 + 20mm
6	AB100-349	KANAT YANI PROFİLİ / Sash Side Profile	FH + 16mm

AKSESUARLAR / ACCESSORIES

MKTAR / Ünit / Qty	KOD / Code	PROFİL ÇİZİMİ / Drawing	PROFİL TANIMI / Description
10 Adet / Pcs	SS-AC-03		ÜST RULMAN / Top Roller
10 Adet / Pcs	SS-AC-0B		ESKİSİZ KASA RULMANI / Bottom Roller
5 TANIMI / Set	SS-AC-0A		KANAT ALT KAPAK / Bottom Sash Cover
1 Adet / Pcs	SS-AC-08		KANAT ALT KAPAK / Bottom Sash Cover
1 Tanım / Set	SS-AC-09		KASA KİŞİYE TAKILAN / Frame Corner Joint
1 Adet / Pcs	SS-AC-10		ÇEMENE KOL / Pull Handle
2 Adet / Pcs	SS-AC-06		GOVENLİK KİLİTLEMESİ / Security Locking
2 Adet / Pcs	SS-AC-11		SÜRME CAM İÇİ KİLİTLEMESİ / Locking For Inside
(KASH + 650) ml	KF-ET-50		FRİÇA FİTİL / Brush Gasket

•SEÇENEK OLARAK EXTRA KULLANILABİLİR - ADDITIONAL AVAILABLE AS OPTION

ESKİSİZ KASA MONTAJI - 8mm CAM İÇİN
SAĞA SÜRÜLÜR KANAT
ASSEMBLY FOR NO THRESHOLD FRAME - FOR 8mm GLASS
SLIDING TO THE RIGHT WAY

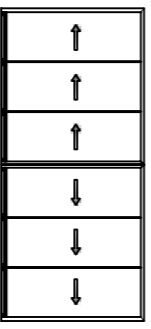

•MAX KANAT YÜKSEKLİĞİ İÇ MEKAN 3000mm, DİŞ MEKAN 2500mm
•MAX KANAT YERİHTİSİ 3000mm İNDECE 2500mm ÖLÇÜDE
•MAX KANAT ENİ 1800mm (TÜPÇAM KANAT ALANI 4m2 Yİ GEÇEMEBİLİR RULMANI TAŞIMA KAPASİTESİ ORTALAMA 8kg)
•MAX SÜRÜLME YERİ 1800mm (TÜPÇAM KANAT ALANI 4m2 Yİ GEÇEMEBİLİR RULMANI TAŞIMA KAPASİTESİ ORTALAMA 8kg)

CAM KESİM ÖLÇÜLERİ / GLASS CUTTING SIZES		
KODU / Code	TANIMI / Description	KESİM ÖLÇÜSÜ / Cutting Dimensions
GW	KANAT CAM GENİŞLİĞİ / Sash Glass Width	(FW - 60) G1 + 15
GH	KANAT CAM YÜKSEKLİĞİ / Sash Glass Height	FH + 15mm

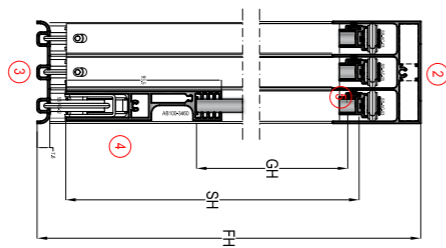

AB100
SÜRME CAM BALKON SİSTEMİ
GLASS SLIDE SYSTEM

PROFİLLER / PROFILES

KOD / ADET / Ünit / Code	PROFİL ÇİZİMİ / Drawing	PROFİL TANIMI / Description	KESİM ÖLÇÜSÜ / Cutting Dimensions
1	AB100-301	YAN KASA PROFİLİ / Vertical Finap Profile	FH - 22mm
2	AB100-301	ÜST KASA PROFİLİ / Top Frame Profile	FW
3	AB100-302	ESKİSİZ ALT KASA PROFİLİ / Bottom Profile with No Threshold	FW
4	AB100-348	ALT KANAT PROFİLİ / Bottom Sash Profile	(FW - 60) G1 + 15
5	AB100-344	ÜST KANAT PROFİLİ / Top Sash Profile	(FW - 60) G1 + 15
6	AB100-349	KANAT YANI PROFİLİ / Sash Side Profile	FH + 16mm

AKSESUARLAR / ACCESSORIES

MKTAR / Ünit / Qty	KOD / Code	PROFİL ÇİZİMİ / Drawing	PROFİL TANIMI / Description
12 Adet / Pcs	SS-AC-03		ÜST RULMANI / Top Roller
12 Adet / Pcs	SS-AC-0B		ESKİSİZ KASA RULMANI / Bottom Roller
3 TANIMI / Set	SS-AC-0A		KANAT ALT KAPAK / Bottom Sash Cover
3 TANIMI / Set	SS-AC-08		KANAT ALT KAPAK / Bottom Sash Cover
1 Tanım / Set	SS-AC-12		ORTA KANAT BİRLEŞTİRME KAPAKLARI / Central Locking Cover
4 Adet / Pcs	AS-PA-124		KASA KİŞİYE TAKILAN / Frame Corner Joint
1 Adet / Pcs	SS-AC-10		ÇEMENE KOL / Pull Handle
4 Adet / Pcs	SS-AC-06		GOVENLİK KİLİTLEMESİ / Security Locking
4 Adet / Pcs	SS-AC-11		SÜRME CAM İÇİ KİLİTLEMESİ / Locking For Inside
(KASH + 650) ml	KF-ET-50		FRİÇA FİTİL / Brush Gasket

•SEÇENEK OLARAK EXTRA KULLANILABİLİR - ADDITIONAL AVAILABLE AS OPTION

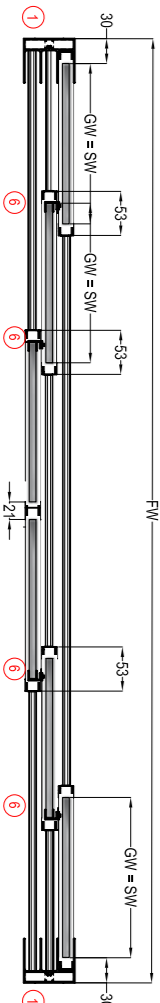

ESKİ KASA MONTAJI - 10mm CAM İÇİN
SAĞA SÜRÜLÜR KANAT ASSEMBLY FOR THRESHOLD FRAME - FOR 10mm GLASS SLIDING TO THE RIGHT WAY

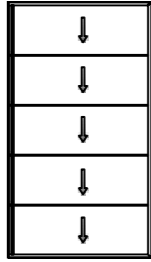

•MAX KANAT YÜKSEKLİĞİ İÇ MEKAN 3000mm, DİŞ MEKAN 2500mm
•MAX SİLİNDİR YERİNE 3000mm İNDESE 2500mm ÖLÇÜSÜNE
•MAX KANAT ENİ 1800mm (TÜRKİYE KANAT ALANI 4m2 YERİNEKELİ RULMANI TAŞIMA KAPASİTESİ ORTALAMA 8kg)
•MAX SİLİNDİR RAYI 800mm (TÜRKİYE SİLİNDİR RAYI 4m2 RULMAN ÇAPRI 20mm)

CAM KESİM ÖLÇÜLERİ / GLASS CUTTING SIZES		KESİM ÖLÇÜSÜ / Cutting Dimensions	
KODU / Code	TANIMI / Description	FW - 60mm / G1 - 20mm	FH - 133,3mm
GW	KANAT CAM GENİŞLİK / Sash Glass Width		
GH	KANAT CAM YÜKSEKLİK / Sash Glass Height		

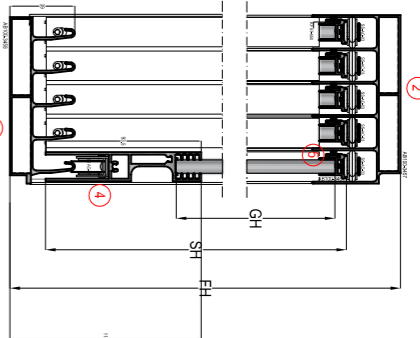

RIGHT SLIDING
SAĞA SÜRÜLÜR KANATLAR

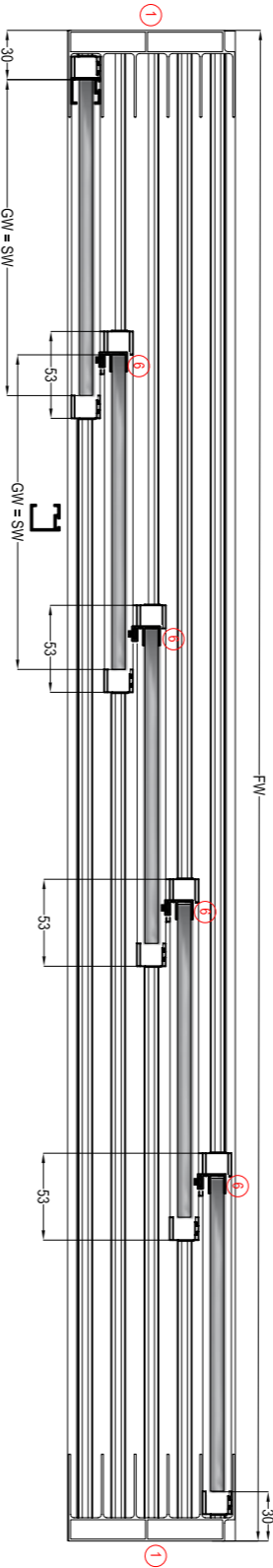

AB100
SİLİNDİR CAM BAĞLAMA SİSTEMİ
GLASS SLIDE SYSTEM

PROFİLLER / PROFILES

KOD / Number	ADET / Unit	KOD / Code	PROFİL ÇİZİMİ / Drawing	PROFİL TANIMI / Description	KESİM ÖLÇÜSÜ / Cutting Dimensions
1	2	AB100-3457		YAN KASA PROFİLİ / Vertical Frame Profile	FH - 22mm
2	1	AB100-3457		ÜST KASA PROFİLİ / Top Frame Profile	FW - 100mm
3	1	AB100-3458		ESKİ KASA PROFİLİ / Bottom Profile with Threshold	FW - 100mm
4	5	AB100-3459		ALT KANAT PROFİLİ / Bottom Sash Profile	FW - 60mm / G1 - 20mm
5	5	Z400-44		ÜST KANAT PROFİLİ / Top Sash Profile	FW - 60mm / G1 - 20mm
6	4	AB100-3465		KANAT YAN PROFİLİ / Sash Side Profile	FH - 160mm

AKSESUARLAR / ACCESSORIES

MKTARI / ULAH	KODU / Code	PROFİL ÇİZİMİ / Drawing	PROFİL TANIMI / Description
10 Adet / Pcs	SS-AC-03		ÜST RULMAN / Top Roller
10 Adet / Pcs	SS-AC-07		ESKİ KASA RULMANI / Bottom Roller
1 Tamam / Set	SS-AC-09C		KANAT ALT KAPAK / Bottom Sash Cover
5 Tamam / Set	SS-AC-08		KANAT ALT KAPAK / Bottom Sash Cover
1 Tamam / Set	SS-AC-09		KASA KİŞİ TARKIZI / Frame Corner Joint
2 Adet / Pcs	SS-AC-10		ÇEMENE KOL / Pull Handle
2 Adet / Pcs	SS-AC-06		GÜVENLİK KİLİTLEMESİ / Security Locking
2 Adet / Pcs	SS-AC-11		SİLİNDİR CAM BAĞLAMA SİSTEMİ / Locking For Inset
(4xSH + 5xSW) ml	KG-ET-50		FRİCŞA FİTİLİ / Brush Gasket

•SEÇENEK OLARAK EXTRA KULLANILABİLİR • ADDITIONAL AVAILABLE AS OPTION

ESKİSİZ KASA MONTAJI - 8mm CAM İÇİN
SOLA SÜRÜLÜR KANAT ASSEMBLY FOR NO THRESHOLD FRAME - FOR 8mm GLASS SLIDING TO THE LEFT WAY

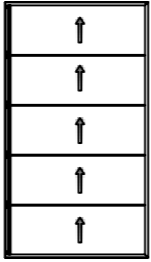

•MAX KANAT YÜKSEKLİĞİ İÇ MEKAN 3000mm, DİŞ MEKAN 2500mm
•MAX SİLİNDİR YERİNE 3000mm İNDESE 2500mm ÖLÇÜSÜNE
•MAX KANAT ENİ 1800mm (TÜRKİYE KANAT ALANI 4m2 YERİNEKELİ RULMANI TAŞIMA KAPASİTESİ ORTALAMA 8kg)
•MAX SİLİNDİR RAYI 800mm (TÜRKİYE SİLİNDİR RAYI 4m2 RULMAN ÇAPRI 20mm)

CAM KESİM ÖLÇÜLERİ / GLASS CUTTING SIZES		KESİM ÖLÇÜSÜ / Cutting Dimensions	
KODU / Code	TANIMI / Description	FW - 60mm / G1 - 20mm	FH - 133mm
GW	KANAT CAM GENİŞLİK / Sash Glass Width		
GH	KANAT CAM YÜKSEKLİK / Sash Glass Height		

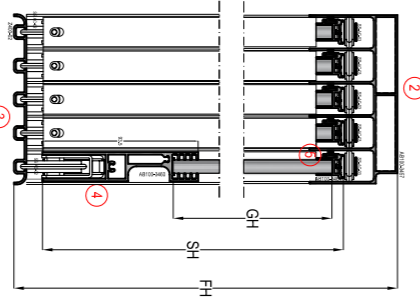

LEFT SLIDING
SOLA SÜRÜLÜR KANATLAR

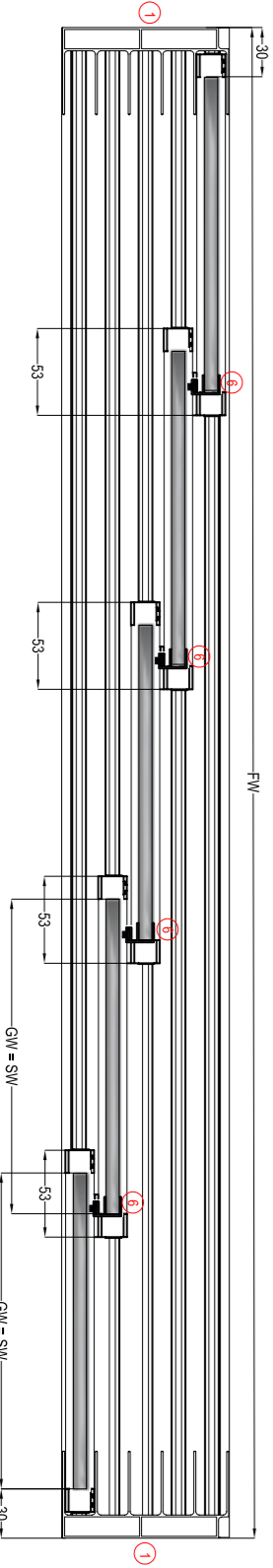

AB100
SİLİNDİR CAM BAĞLAMA SİSTEMİ
GLASS SLIDE SYSTEM

PROFİLLER / PROFILES

KOD / Number	ADET / Unit	KOD / Code	PROFİL ÇİZİMİ / Drawing	PROFİL TANIMI / Description	KESİM ÖLÇÜSÜ / Cutting Dimensions
1	2	AB100-3457		YAN KASA PROFİLİ / Vertical Frame Profile	FH - 22mm
2	1	AB100-3457		ÜST KASA PROFİLİ / Top Frame Profile	FW - 100mm
3	1	Z400-02		ESKİSİZ ALT KASA PROFİLİ / Bottom Profile with No Threshold	FW
4	5	AB100-3460		ALT KANAT PROFİLİ / Bottom Sash Profile	FW - 60mm / G1 - 20mm
5	5	AB100-3464		ÜST KANAT PROFİLİ / Top Sash Profile	FW - 60mm / G1 - 20mm
6	4	AB100-3465		KANAT YAN PROFİLİ / Sash Side Profile	FH - 160mm

AKSESUARLAR / ACCESSORIES

MKTARI / ULAH	KODU / Code	PROFİL ÇİZİMİ / Drawing	PROFİL TANIMI / Description
10 Adet / Pcs	SS-AC-03		ÜST RULMAN / Top Roller
10 Adet / Pcs	SS-AC-08		ESKİSİZ KASA RULMANI / Bottom Roller
1 Tamam / Set	SS-AC-08A		KANAT ALT KAPAK / Bottom Sash Cover
5 Tamam / Set	SS-AC-08B		KANAT ALT KAPAK / Bottom Sash Cover
1 Tamam / Set	SS-AC-09		KASA KİŞİ TARKIZI / Frame Corner Joint
1 Adet / Pcs	SS-AC-10		ÇEMENE KOL / Pull Handle
2 Adet / Pcs	SS-AC-06		GÜVENLİK KİLİTLEMESİ / Security Locking
2 Adet / Pcs	SS-AC-11		SİLİNDİR CAM BAĞLAMA SİSTEMİ / Locking For Inset
(4xSH + 5xSW) ml	KG-ET-50		FRİCŞA FİTİLİ / Brush Gasket

•SEÇENEK OLARAK EXTRA KULLANILABİLİR • ADDITIONAL AVAILABLE AS OPTION

ESİKLİ KASA MONTAJI - 8mm CAM İÇİN
SAĞA SÜRÜLÜR KANAT ASSEMBLY FOR THRESHOLD FRAME - FOR 8mm GLASS SLIDING TO THE RIGHT WAY

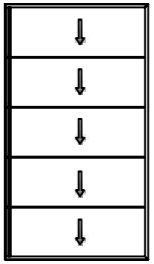

•MAX KANAT YÜKSEKLİĞİ İÇ MEKAN 3000mm, DİŞ MEKAN 2500mm
•MAX SİLİNDİR YERİTİSİ 3000mm İNDESE 2500mm ÖLÇÜDE
•MAX KANAT ENİ 1800mm (TİPİKAL KANAT ALANI 4m2 Yİ GEÇEMEBİLİR RULMANI TAŞIYAN KAYIŞTESİ ORTALAMA 8kg)
•MAX SİLİNDİR YERİTİSİ 800mm (TİPİKAL SİLİNDİR YERİTİSİ 600mm İNDE 400 ROLLER ÇAMUR ÇAĞIRTISI 8kg)

CAM KESİM ÖLÇÜLERİ / GLASS CUTTING SIZES		
KODU / Code	TANIMI / Description	KESİM ÖLÇÜSÜ / Cutting Dimensions
GW	KANAT CAM GENİŞLİĞİ / Sash Glass Width	(FW - 60mm G) + 20mm
GH	KANAT CAM YÜKSEKLİĞİ / Sash Glass Height	FH - 133,3mm

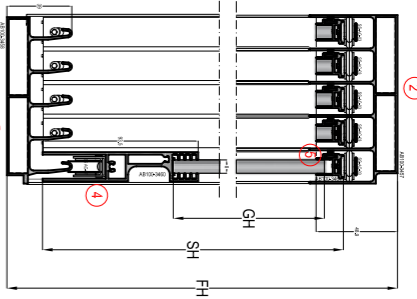

RIGHT SLIDING
SAĞA SÜRÜLÜR KANATLAR

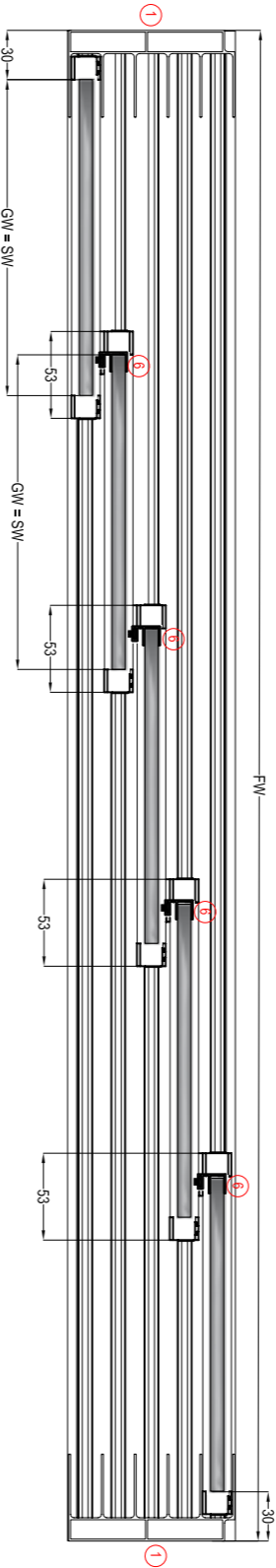

AB100
SİLİNDİR CAM BAĞLAMA SİSTEMİ
GLASS SLIDE SYSTEM

PROFİLLER / PROFILES

KOD / Number	ADET / Unit	KOD / Code	PROFİL ÇİZİMİ / Drawing	PROFİL TANIMI / Description	KESİM ÖLÇÜSÜ / Cutting Dimensions
1	2	AB100-3457		YAN KASA PROFİLİ / Vertical Frame Profile	FH - 250mm
2	1	AB100-3457		ÜST KASA PROFİLİ / Top Frame Profile	FW - 100mm
3	1	AB100-3458		ESİKLİ ALT KASA PROFİLİ / Bottom Profile with Threshold	FW - 100mm
4	5	AB100-3459		ALT KANAT PROFİLİ / Bottom Sash Profile	(FW - 60mm) G + 20mm SH - 200mm
5	5	AB100-3464		ÜST KANAT PROFİLİ / Top Sash Profile	(FW - 60mm) G + 20mm SH - 200mm
6	4	AB100-3465		KANAT YAN PROFİLİ / Sash Side Profile	FH - 160mm

AKSESUARLAR / ACCESSORIES

MKTARI / ULAH	KOD / Code	PROFİL ÇİZİMİ / Drawing	PROFİL TANIMI / Description
10 Adet / Pcs	SS-AC-03		ÜST RULMAN / Top Roller
10 Adet / Pcs	SS-AC-07		ESİKLİ KASA RULMANI / Bottom Roller
5 Tamlı / Sd	SS-AC-09C		KANAT ALT KAPAK / Bottom Sash Cover
1 Tamlı / Sd	SS-AC-00		KANAT ALT KAPAK / Bottom Sash Cover
1 Tamlı / Sd	SS-AC-09		KASA KİŞİTİMİ / Frame Corner Joint
1 Adet / Pcs	SS-AC-10		ÇEMENE KOL / Pull Handle
2 Adet / Pcs	SS-AC-06		GÜVENLİK KİLİTLEMESİ / Security Locking
2 Adet / Pcs	SS-AC-11		SİLİNDİR CAM BAĞLAMA SİSTEMİ / Locking For Inside
(4xSH + 5xSW) ml	KG-ET-050		FRİCZA FTTL / Brush Gasket

•SEÇENEK OLARAK EXTRA KULLANILABİLİR • ADDITIONAL AVAILABLE AS OPTION

ESİKLİ KASA MONTAJI - 10mm CAM İÇİN
SOLA SÜRÜLÜR KANAT ASSEMBLY FOR THRESHOLD FRAME - FOR 10mm GLASS SLIDING TO THE LEFT WAY

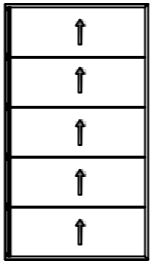

•MAX KANAT YÜKSEKLİĞİ İÇ MEKAN 3000mm, DİŞ MEKAN 2500mm
•MAX SİLİNDİR YERİTİSİ 3000mm İNDESE 2500mm ÖLÇÜDE
•MAX KANAT ENİ 1800mm (TİPİKAL KANAT ALANI 4m2 Yİ GEÇEMEBİLİR RULMANI TAŞIYAN KAYIŞTESİ ORTALAMA 8kg)
•MAX SİLİNDİR YERİTİSİ 800mm (TİPİKAL SİLİNDİR YERİTİSİ 600mm İNDE 400 ROLLER ÇAMUR ÇAĞIRTISI 8kg)

CAM KESİM ÖLÇÜLERİ / GLASS CUTTING SIZES		
KODU / Code	TANIMI / Description	KESİM ÖLÇÜSÜ / Cutting Dimensions
GW	KANAT CAM GENİŞLİĞİ / Sash Glass Width	(FW - 60mm G) + 20mm
GH	KANAT CAM YÜKSEKLİĞİ / Sash Glass Height	FH - 133,3mm

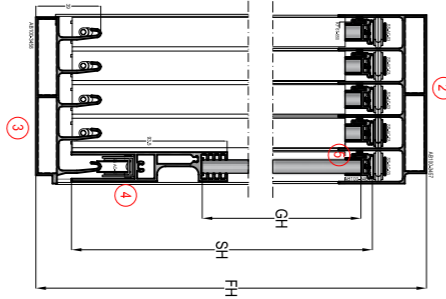

LEFT SLIDING
SOLA SÜRÜLÜR KANATLAR

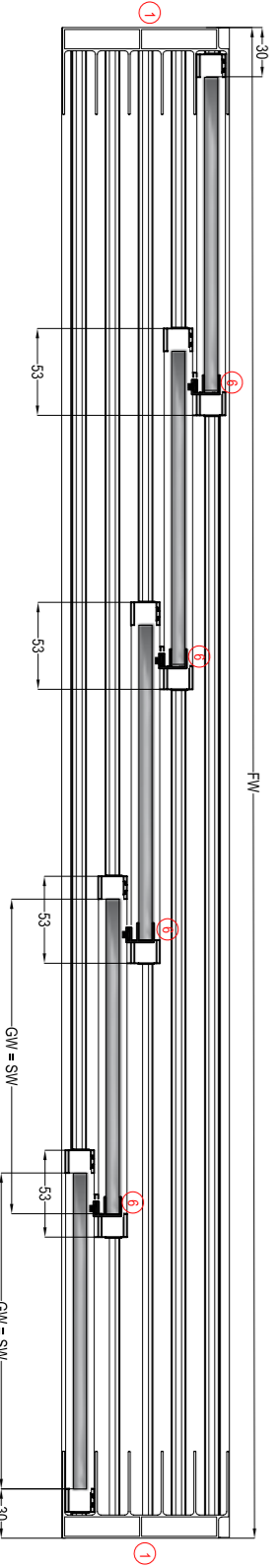

AB100
SİLİNDİR CAM BAĞLAMA SİSTEMİ
GLASS SLIDE SYSTEM

PROFİLLER / PROFILES

KOD / Number	ADET / Unit	KOD / Code	PROFİL ÇİZİMİ / Drawing	PROFİL TANIMI / Description	KESİM ÖLÇÜSÜ / Cutting Dimensions
1	2	AB100-3457		YAN KASA PROFİLİ / Vertical Frame Profile	FH - 250mm
2	1	AB100-3457		ÜST KASA PROFİLİ / Top Frame Profile	FW - 100mm
3	1	AB100-3458		ESİKLİ ALT KASA PROFİLİ / Bottom Profile with Threshold	FW - 100mm
4	5	AB100-3459		ALT KANAT PROFİLİ / Bottom Sash Profile	(FW - 60mm) G + 20mm SH - 200mm
5	5	Z400-04		ÜST KANAT PROFİLİ / Top Sash Profile	(FW - 60mm) G + 20mm SH - 200mm
6	4	AB100-3465		KANAT YAN PROFİLİ / Sash Side Profile	FH - 160mm

AKSESUARLAR / ACCESSORIES

MKTARI / ULAH	KOD / Code	PROFİL ÇİZİMİ / Drawing	PROFİL TANIMI / Description
10 Adet / Pcs	SS-AC-03		ÜST RULMAN / Top Roller
10 Adet / Pcs	SS-AC-07		ESİKLİ KASA RULMANI / Bottom Roller
5 Tamlı / Sd	SS-AC-09C		KANAT ALT KAPAK / Bottom Sash Cover
1 Adet / Pcs	SS-AC-00		KANAT ALT KAPAK / Bottom Sash Cover
1 Tamlı / Sd	SS-AC-09		KASA KİŞİTİMİ / Frame Corner Joint
1 Adet / Pcs	SS-AC-10		ÇEMENE KOL / Pull Handle
2 Adet / Pcs	SS-AC-06		GÜVENLİK KİLİTLEMESİ / Security Locking
2 Adet / Pcs	SS-AC-11		SİLİNDİR CAM BAĞLAMA SİSTEMİ / Locking For Inside
(4xSH + 5xSW) ml	KG-ET-050		FRİCZA FTTL / Brush Gasket

•SEÇENEK OLARAK EXTRA KULLANILABİLİR • ADDITIONAL AVAILABLE AS OPTION

EŞİKLİ KASA MONTAJI - 8mm CAM İÇİN
ASSEMBLY FOR THRESHOLD FRAME - FOR 8mm GLASS

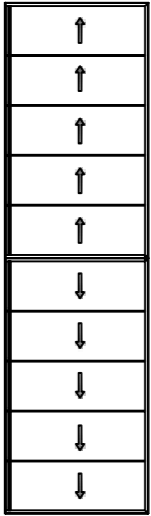

•MAX KANAT YÜKSEKLİĞİ İÇ MEKAN 3000mm, DİŞ MEKAN 2500mm
•MAX KANAT YERİNE 3500mm İNDE 2500mm ÖRTÜSE
•MAX KANAT ENİ 1800mm (TİPÇAM KANAT ALANI 4x2 YERİNEKELİ RULMANI TAŞIMA KAPAKSİZİSİ ORTALAMA 8kg)
•MAX SİLİNDİR ÇAP 1800mm (TİPÇAM KANAT ALANI 4x2 YERİNEKELİ RULMANI TAŞIMA KAPAKSİZİSİ 8kg)

CAM KESİM ÖLÇÜLERİ / GLASS CUTTING SIZES

KOD / Code	TANIMI / Description	KESİM ÖLÇÜSÜ / Cutting Dimensions
GW	KANAT CAM GENİŞLİK / Sash Glass Width	(FW-60)/10+12
GH	KANAT CAM YÜKSEKLİK / Sash Glass Height	FH - 133,3mm

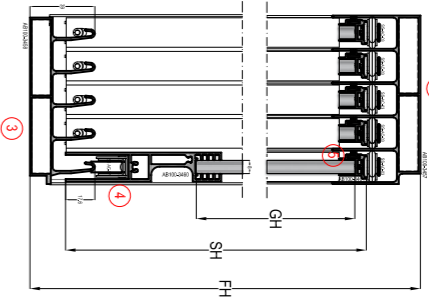

KOD / ADET / Ünit / Code	PROFİL ÇİZİMİ / Drawing	PROFİL TANIMI / Description	KESİM ÖLÇÜSÜ / Cutting Dimensions
1	2	YAN KASA PROFİLİ / Vertical Frame Profile	FH - 250mm
2	1	ÜST KASA PROFİLİ / Top Frame Profile	FW - 100mm
3	1	EŞİKLİ ALT KASA PROFİLİ / Bottom Profile with Threshold	FW - 100mm
4	10	ALT KANAT PROFİLİ / Bottom Sash Profile	(FW-60)/10+12
5	10	ÜST KANAT PROFİLİ / Top Sash Profile	(FW-60)/10+12
6	8	KANAT YAN PROFİLİ / Sash Side Profile	FH - 168mm

AKSESUARLAR / ACCESSORIES

ULKE/RE ÜNİT / Code	PROFİL ÇİZİMİ / Drawing	PROFİL TANIMI / Description
20 Adet / Pcs	SS AC-03	ÜST RULMAN / Top Roller
10 Adet / Pcs	SS AC-07	EŞİKLİ KASA RULMANI / Bottom Roller
3 Tahmin / Sht	SS AC-08C	KANAT ALT KAPAK / Bottom Sash Cover
3 Tahmin / Sht	SS AC-08D	KANAT ALT KAPAK / Bottom Sash Cover
1 Tahmin / Sht	SS AC-12	ORTA KANAT BİRLEŞİM KAPAKLARI / Central Locking Cover
1 Tahmin / Sht	SS AC-09	KASA KÖŞE TAVANZI / Frame Corner Joint
1 Adet / Pcs	SS AC-10	ÇEMEKE KOL / Pull Handle
4 Adet / Pcs	SS AC-06	GÜVENLİK KİLİTLERİ / Security Locking
4 Adet / Pcs	SS AC-11	SİLİNDİR CAM İÇ KİLİTLERİ / Locking for Inside
(KASH + 6x50) mt	KF 67-650	FİRCAY FİRLİ / Brush Gasket

•SEÇENEK OLARAK EXTRA KULLANILABİLİR - ADDITIONAL AVAILABLE AS OPTION

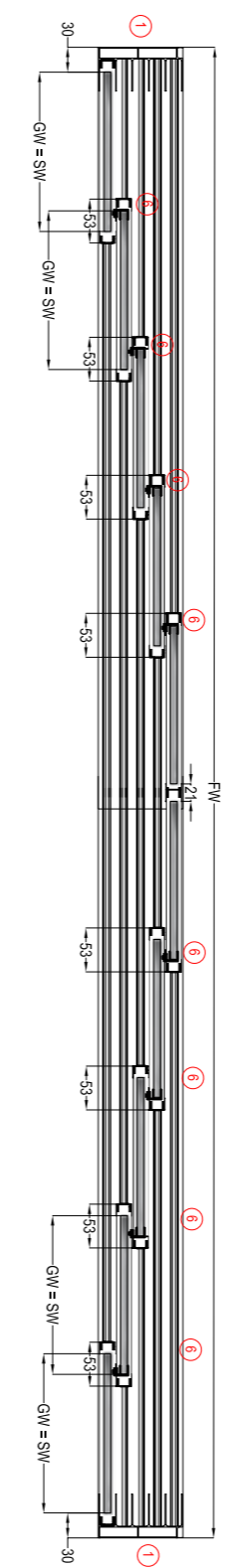

AB100
SİLİNDİR CAM BAĞLAMA SİSTEMİ
GLASS SLIDE SYSTEM

EŞİKLİ KASA MONTAJI - 8mm CAM İÇİN
ASSEMBLY FOR THRESHOLD FRAME - FOR 8mm GLASS
SLIDING TO THE LEFT WAY

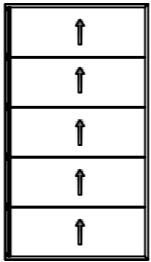

•MAX KANAT YÜKSEKLİĞİ İÇ MEKAN 3000mm, DİŞ MEKAN 2500mm
•MAX KANAT YERİNE 3500mm İNDE 2500mm ÖRTÜSE
•MAX KANAT ENİ 1800mm (TİPÇAM KANAT ALANI 4x2 YERİNEKELİ RULMANI TAŞIMA KAPAKSİZİSİ ORTALAMA 8kg)
•MAX SİLİNDİR ÇAP 1800mm (TİPÇAM KANAT ALANI 4x2 YERİNEKELİ RULMANI TAŞIMA KAPAKSİZİSİ 8kg)

KOD / Code	TANIMI / Description	KESİM ÖLÇÜSÜ / Cutting Dimensions
GW	KANAT CAM GENİŞLİK / Sash Glass Width	(FW - 60mm) / 9 - 20mm
GH	KANAT CAM YÜKSEKLİK / Sash Glass Height	FH - 133,3mm

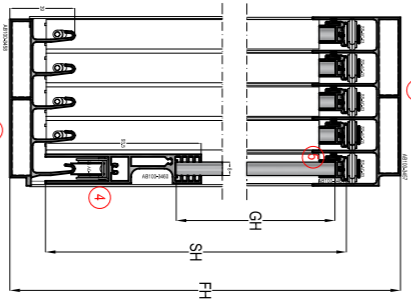

LEFT SLIDING
SOLA SÜRÜLÜR KANATLAR

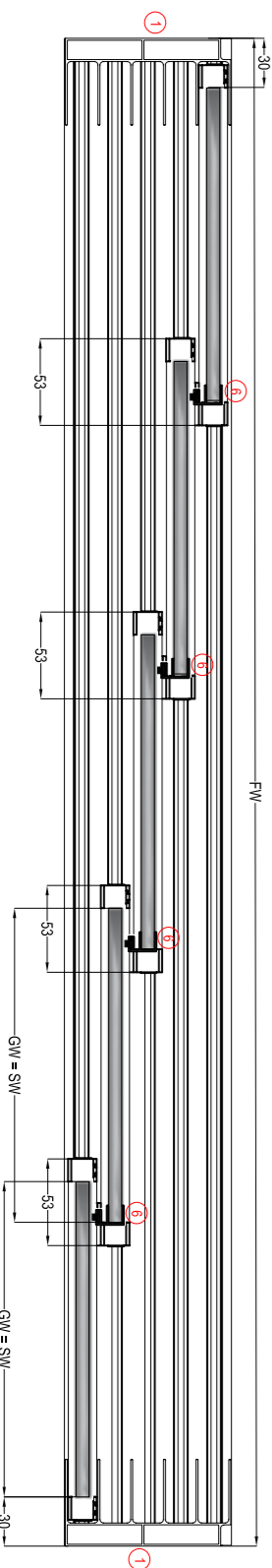

AB100
SİLİNDİR CAM BAĞLAMA SİSTEMİ
GLASS SLIDE SYSTEM

PROFİLLER / PROFILES

KOD / ADET / Ünit / Code	PROFİL ÇİZİMİ / Drawing	PROFİL TANIMI / Description	KESİM ÖLÇÜSÜ / Cutting Dimensions
1	2	YAN KASA PROFİLİ / Vertical Frame Profile	FH - 250mm
2	1	ÜST KASA PROFİLİ / Top Frame Profile	FW - 100mm
3	1	EŞİKLİ ALT KASA PROFİLİ / Bottom Profile with Threshold	FW - 100mm
4	5	ALT KANAT PROFİLİ / Bottom Sash Profile	(FW-60)/10+12
5	5	ÜST KANAT PROFİLİ / Top Sash Profile	(FW-60)/10+12
6	4	KANAT YAN PROFİLİ / Sash Side Profile	FH - 168mm

AKSESUARLAR / ACCESSORIES

MİKTAR / ÜNİT / Code	PROFİL ÇİZİMİ / Drawing	PROFİL TANIMI / Description
10 Adet / Pcs	SS AC-03	ÜST RULMAN / Top Roller
10 Adet / Pcs	SS AC-07	EŞİKLİ KASA RULMANI / Bottom Roller
1 Adet / Pcs	SS AC-08C	KANAT ALT KAPAK / Bottom Sash Cover
4 Adet / Pcs	SS AC-08D	KANAT ALT KAPAK / Bottom Sash Cover
5 Adet / Pcs	SS AC-08E	KANAT ALT KAPAK / Bottom Sash Cover
1 Tahmin / Sht	SS AC-09	KASA KÖŞE TAVANZI / Frame Corner Joint
1 Adet / Pcs	SS AC-10	ÇEMEKE KOL / Pull Handle
2 Adet / Pcs	SS AC-06	GÜVENLİK KİLİTLERİ / Security Locking
2 Adet / Pcs	SS AC-11	SİLİNDİR CAM İÇ KİLİTLERİ / Locking for Inside
(KASH + 6x50) mt	KF 67-650	FİRCAY FİRLİ / Brush Gasket

•SEÇENEK OLARAK EXTRA KULLANILABİLİR - ADDITIONAL AVAILABLE AS OPTION

ESKISIZ KASA MONTAJI - 8mm CAM ION
ASSEMBLY FOR NO THRESHOLD FRAME - FOR 8mm GLASS

•MAX KANAT YÜKSEKLİĞİ/ÇİMEKAN 3000mm, DİŞ NERKAN 2500mm
MAX SAĞI YERİ/Ş 3000mm AĞIĞE 2500mm ÇU/ŞİÇE

•MAX KANAT ENİ/800mm TOPRAK KANAT ALMAN 4x12 Yİ GEÇEMELİ RULMAN TAŞIYMA KAPAKLARI
ORJALAMA 80x83

MAX SAĞI YERİ/Ş 3000mm (TOZLA SAĞI YERİ/ŞİÇE MUST BE SMALLER THAN THE MAX ROLLER CAPT CHARGE IS 80x)

KOD / Code	TANIMI / Description	KESİM ÖLÇÜSÜ / Cutting Dimensions
GW	KANAT CAM GENİŞLİĞİ / Sash Glass Width	(F1+80)/10+12
GH	KANAT CAM YÜKSEKLİĞİ / Sash Glass Height	FH - 183,2mm

KESİM ÖLÇÜSÜ / CUTTING SIZES

PROFİLER / PROFILES

NO / Number	ADET / Unit	KOD / Code	PROFİL ÇİZİM / Drawing	PROFİL TANIMI / Description	KESİM ÖLÇÜSÜ / Cutting Dimensions
1	2	AB100345T		YAN KASA PROFİLİ / Vertical Frame Profile	FH - 22mm
2	1	AB100345T		ÜST KASA PROFİLİ / Top Frame Profile	F1V - 10mm
3	1	Z60-02		ESKİSİZ ALT KASA PROFİLİ / Bottom Profile with no threshold	F1V
4	10	AB100348D		ALT KANAT PROFİLİ / Bottom Sash Profile	(F1+80)/10+12
5	10	AB100348A		ÜST KANAT PROFİLİ / Top Sash Profile	(F1+80)/10+12
6	8	AB100348S		KANAT YAN PROFİLİ / Sash Side Profile	FH - 183mm

AKSESUARLAR / ACCESSORIES

MİKTAR / Unit	KOD / Code	PROFİL ÇİZİM / Drawing	PROFİL TANIMI / Description
20 Adet / Pcs	SS-AC03		ÜST RULMAN / Top roller
10 Adet / Pcs	SS-AC07		ESKİSİZ KASA RULMANI / Bottom roller
5 Talam / Set	SS-AC08A		KANAT ALT KAPAK / Bottom Sash Cover
5 Talam / Set	SS-AC08B		KANAT ALT KAPAK / Bottom Sash Cover
1 Talam / Set	SS-AC12		ORTA KANAT BİRLİŞİM KAPAKLARI / Central Locking Cover
1 Talam / Set	SS-AC09		KASA KİÇİĞE TAKOZU / Frame Corner Joint
4 Adet / Pcs	SS-AC10		GENİŞ KOL / Pull Handle
4 Adet / Pcs	SS-AC06		GÜVENLİK KİLİTLEMESİ / Security Locking
4 Adet / Pcs	SS-AC11		SİPİRİE CAM İÇ KLİTLEMESİ / Locking For Inside
(4SH + 5ASV) mt	MF-ET450		FİRÇA F1H1 / Brush Gasket

⚠️ SEÇİLEN QVAKK EXTRA KULLANILABİLİR - ADDITIONAL AVAILABLE AS OPTION

AB100
SİPİRİE CAM BALIKON SİSTEMİ
GLASS SLIDE SYSTEM

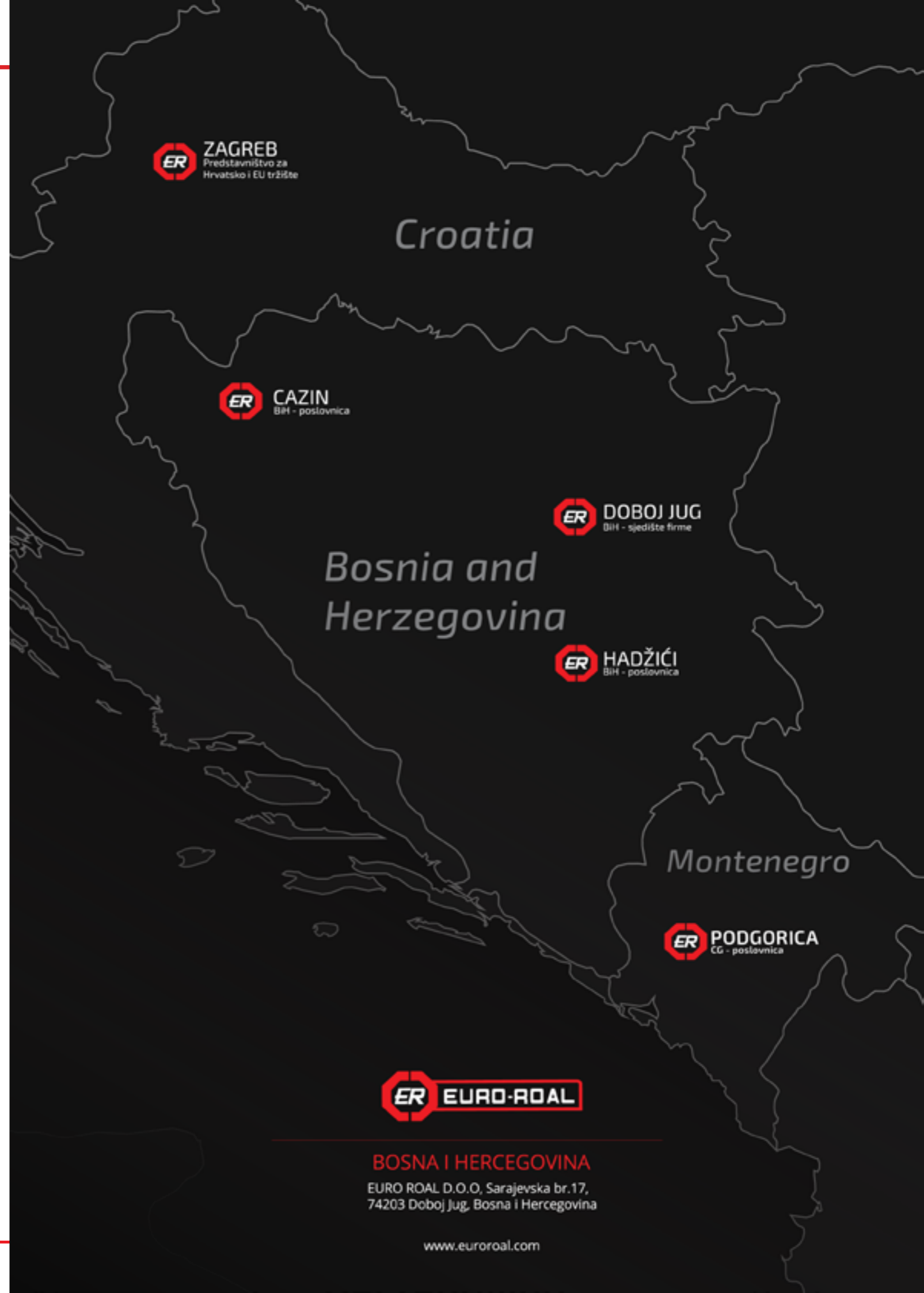

ER ZAGREB
Predstavništvo za Hrvatsko i EU tržište

ER CAZIN
BiH - poslovica

ER DOBOJ JUG
BiH - sjedište firme

ER HADŽIĆI
BiH - poslovica

ER PODGORICA
CG - poslovica